

Section II.

TM 9-2320-272-34P-2

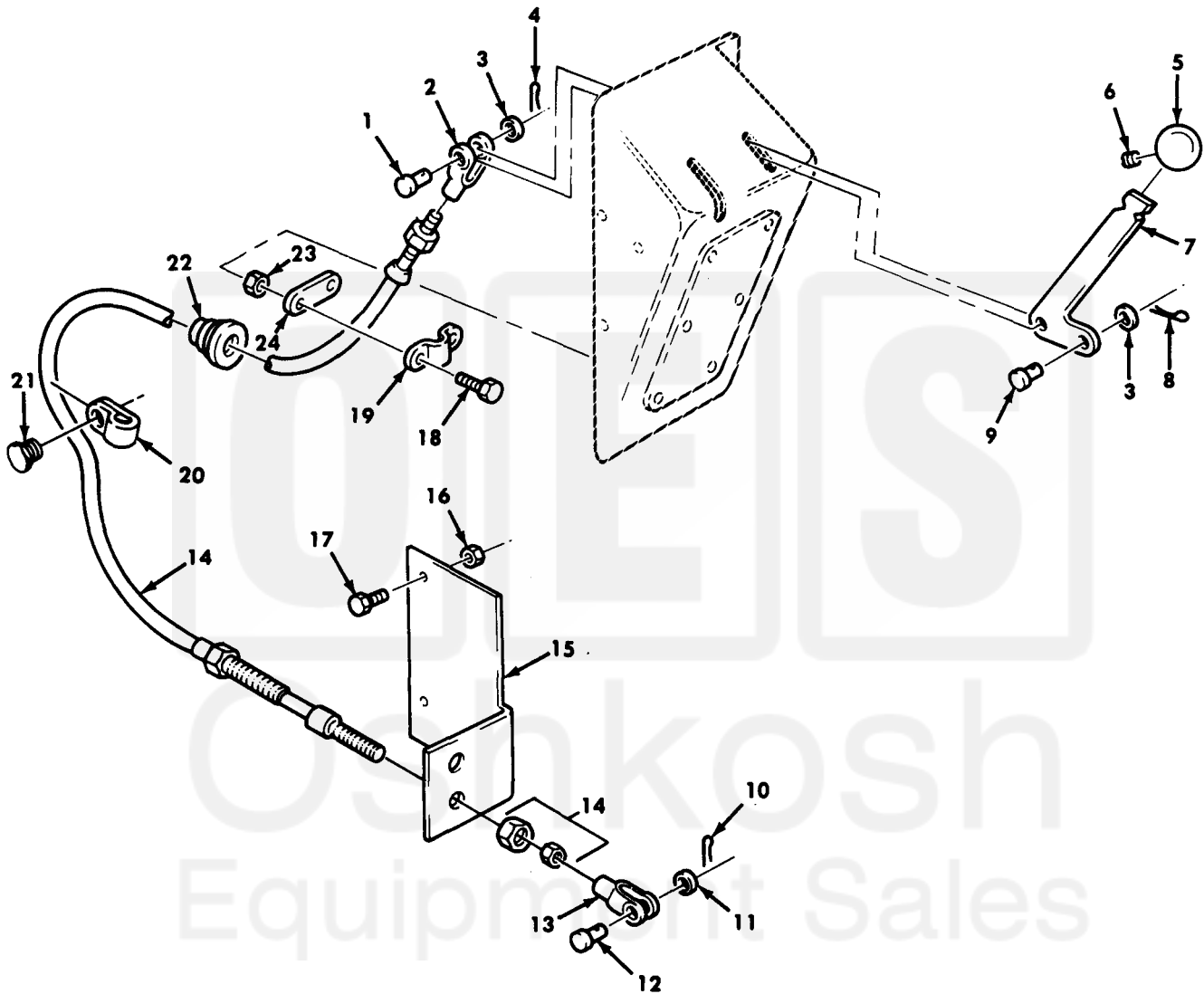

TA 156693

Figure 371. Front Winch Controls and Mounting Hardware.

Current part is item (13) on diagram. Available at www.oshkoshequipment.com

(1)	(2)	(3)	(4)	(5)	(6)	(7)	(8)
ILLUS.							QTY
(a)	(b)	SMR	NATIONAL	PART	DESCRIPTION	U/M	INC
FIG. NO.	ITEM NO.	CODE	STOCK NUMBER	NUMBER	FSCM	USABLE ON CODE	IN UNIT
					GROUP 20 HOIST, WINCH AND POWER TAKE-OFF 2001 HOIST, CRANE, OR WINCH ASSEMBLY FIG. 371 FRONT WINCH CONTROLS AND MOUNTING HARDWARE		
371	1	PAOZZ	5315-00-081-7874	MS20392-3C23	96906	PIN, STRAIGHT, HEADED UOC: DAB, DAD, DAF, DAH, DAL, DAQ, DAV, DAX, V06, V12, V14, V16, V18, V19, V21, V39	EA 1
371	2	PAFZZ	5340-00-865-9496	MS35812-2	96906	CLEVIS, ROD END UOC: DAB, DAD, DAF, DAH, DAL, DAQ, DAV, DAX, V06, V12, V14, V16, V18, V19, V21, V39	EA 1
371	3	PAOZZ	5310-00-809-4058	MS27183-10	96906	WASHER, FLAT UOC: DAB, DAD, DAF, DAH, DAL, DAQ, DAV, DAX, V06, V12, V14, V16, V18, V19, V21, V39	EA 2
371	4	PAOZZ	5315-00-234-1854	MS24665-153	96906	PIN, COTTER UOC: DAB, DAD, DAH, DAL, DAQ, DAV, DAX, V06, V12, V14, V16, V18, V19, V21, V39	EA 1
371	5	PAFZZ	5355-01-107-4178	12276921-1	19207	KNOB UOC: DAB, DAD, DAF, DAH, DAL, DAQ, DAV, DAX, V06, V12, V14, V16, V18, V19, V21, V39	EA 1
371	6	PAFZZ	5305-00-723-4383	MS51963-67	96906	SETSCREW UOC: DAB, DAD, DAF, DAH, DAL, DAQ, DAV, DAX, V06, V12, V14, V16, V18, V19, V21, V39	EA 2
371	7	PPFZZ	3040-01-104-9152	12276914	198207	LEVER, MANUAL CONTROL UOC: DAB, DAD, DAF, DAH, DAL, DAQ, DAV, DAX, V06, V12, V14, V16, V18, V19, V21, V39	EA 1
371	8	PAFZZ	5315-00-815-1405	MS24665-151	96906	PIN, COTTER UOC: DAB, DAD, DAF, DAH, DAL, DAQ, DAV, DAX, V06, V12, V14, V16, V18, V19, V21, V39	EA 1
371	9	PAFZZ	5315-00-063-7366	MS20392-3C17	96906	PIN, STRAIGHT, HEADED UOC: DAB, DAD, DAF, DAH, DAL, DAQ, DAV, DAX, V06, V12, V14, V16, V18, V19, V21, V39	EA 1
371	10	PAOZZ	5315-00-234-1863	AN381-3-12	96906	PIN, COTTER UOC: DAB, DAD, DAF, DAH, DAL, DAQ, DAV, DAX, V06, V12, V14, V16, V18, V19, V21, V39	EA 1
371	11	PAOZZ	5310-00-080-6004	MS27183-14	96906	WASHER, FLAT UOC: DAB, DAD, DAF, DAH, DAL, DAQ, DAV, DAX, V06, V12, V14, V16, V18, V19, V21, V39	EA 1
371	12	PAOZZ	5315-00-990-2889	MS20392-5C31	96906	PIN, STRAIGHT, HEADED UOC: DAB, DAD, DAF, DAH, DAL, DAQ, DAV, DAX, V06, V12, V14, V16, V18, V19, V21, V39	EA 1
371	13	PAFZZ	5340-01-104-9005	12276916	19207	CLEVIS, ROD END UOC: DAB, DAD, DAF, DAH, DAL, DAQ, DAV, DAX, V06, V12, V14, V16, V18, V19, V21, V39	EA 1
371	14	PAFZZ	4010-01-112-6562	11669464	19207	WIRE ROPE ASSEMBLY UOC: DAB, DAD, DAF, DAH, DAL, DAQ, DAV, DAX, V06, V12, V14, V16, V18, V19, V21, V39	EA 1
371	15	PPFZZ	5340-01-107-5221	12276906	19207	BRACKET, ANGLE UOC: DAB, DAD, DAF, DAH, DAQ, DAX, V12, V14, V16, V19, V21	EA 1
371	15	PPFZZ	5340-01-210-7510	12302753	19207	BRACKET UOC: DAL, DAV, V18, V39	EA 1
371	16	PAFZZ	5310-00-814-0672	MS51943-36	96906	NUT, SELF-LOCKING UOC: DAB, DAD, DAF, DAH, DAL, DAQ, DAV, DAX, V06, V12, V14, V16, V18, V19, V21, V39	EA 2

371-1

Current part is item (13) on diagram. Available at www.oshkoshequipment.com