

(1)	(2)	(3)	(4)	(5)	(6)	(7)	(8)
ILLUS.							QTY
(a)	(b)	SMR	NATIONAL	PART		DESCRIPTION	U/M
FIG.	ITEM	CODE	STOCK	NUMBER	FSCM		INC
NO.	NO.		NUMBER			USABLE ON CODE	IN
							UNIT
						1802-FENDERS, RUNNING BOARDS, WITH MOUNTING AND ATTACHING PARTS, OUTRIGGERS, WINDSHIELD, GLASS ETC.(CONT'D)	
136	22	PAFZZ	2510-00-737-3326	7373326	19207	PLATE: CATCH, WINDSHIELD INNER FRAME LOCKING HANDLE	EA 2
136	23	MFFZZ	9390-00-599-6405	7373333	19207	RUBBER, SPECIAL, SHAPED SECTION: (FABRICATED FROM BULK), WINDSHIELD OUTER FRAME TO DOOR GLASS, UPPER, LH	EA 1
136	23	MFFZZ		7373332	19207	RUBBER, SPECIAL, SHAPED SECTION: (FABRICATED FROM BULK, 9390-00-599-6405, 8324457), WINDSHIELD OUTER FRAME TO DOOR GLASS, UPPER, RH	EA 1
136	24	MFFZZ	9390-00-641-1119	7373334	19207	RUBBER, SPECIAL, SHAPED SECTION: (FABRICATED FROM BULK, 9390-00-641-1119, 8324456), WINDSHIELD OUTER FRAME TO DOOR GLASS, LOWER	EA 1
136	25	PAFZZ	5305-00-052-6914	MS24629-34	96906	SCREW	EA 8
136	26	PAFZZ	2510-00-693-0608	7373324	19207	RETAINER	EA 2
136	27	PAFZZ	2510-00-693-0610	7373336	19207	RETAINER, WINDSHIELD	EA 2
136	28	PAFZZ	2510-00-736-8622	7368622	19207	BRACKET: WINDSHIELD, W/ WEATHERSTRIP	EA 2
136	29	PAFZZ	5305-00-855-0960	MS24629-36	96906	SCREW	EA 2
136	30	XAFZZ		7368624	19207	PLATE	EA 1
136	31	PAFZZ	2510-00-409-3993	7368623	19207	WEATHERSTRIP	EA 1
136	32	XAFZZ		7368625	19207	BRACKET	EA 1
136	33	PAFZZ	9390-00-737-3337	7373337	19207	RUBBER, SPECIAL, SHAPED SECTION: WINDSHIELD TO COWL 54-13/16 LONG	EA 1
136	34	PAFZZ	2510-00-737-3331	7373331	19207	FRAME: WINDSHIELD, OUTER	EA 1
137	1	PAFZZ	5310-00-984-3807	MS51922-13	96906	NUT, SELF-LOCKING	EA 6
137	2	PAFZZ	5310-00-484-5833	8330169	19207	WASHER, FLAT	EA 6
137	3	PAFZZ	5306-00-250-4578	8330168	19207	BOLT, MACHINE	EA 6
137	4	PAFZZ	5310-00-081-4219	MS27183-12	19207	WASHER, FLAT	EA 12
137	5	PAFZZ	5360-00-752-1975	7521975	19207	SPRING, HELICAL	EA 6
137	6	PAFZZ	5365-00-134-5020	8757726	19207	SPACER, FENDER MOUNT	EA 2
137	7	PAFZZ	5310-00-959-1488	MS51922-21	96906	NUT, SELF-LOCKING	EA 3
137	8	PAFZZ	5305-00-269-2801	MS90726-58	96906	SCREW, CAP, HEXAGON HEAD	EA 3
137	9	PAFZZ	5310-00-879-7929	BW424A	93480	WASHER, FLAT	EA 4
137	10	PAFZZ	5305-00-042-5592	425592	24617	SCREW	EA 4
137	11	PAFZZ	5306-00-225-9089	MS90726-34	96906	BOLT, MACHINE	EA 4
137	12	PAFZZ	5305-00-569-8909	7372083	19207	SCREW, ASSEMBLED WASHER	EA 8

Current part is item (33) on diagram. Available at www.oshkoshequipment.com

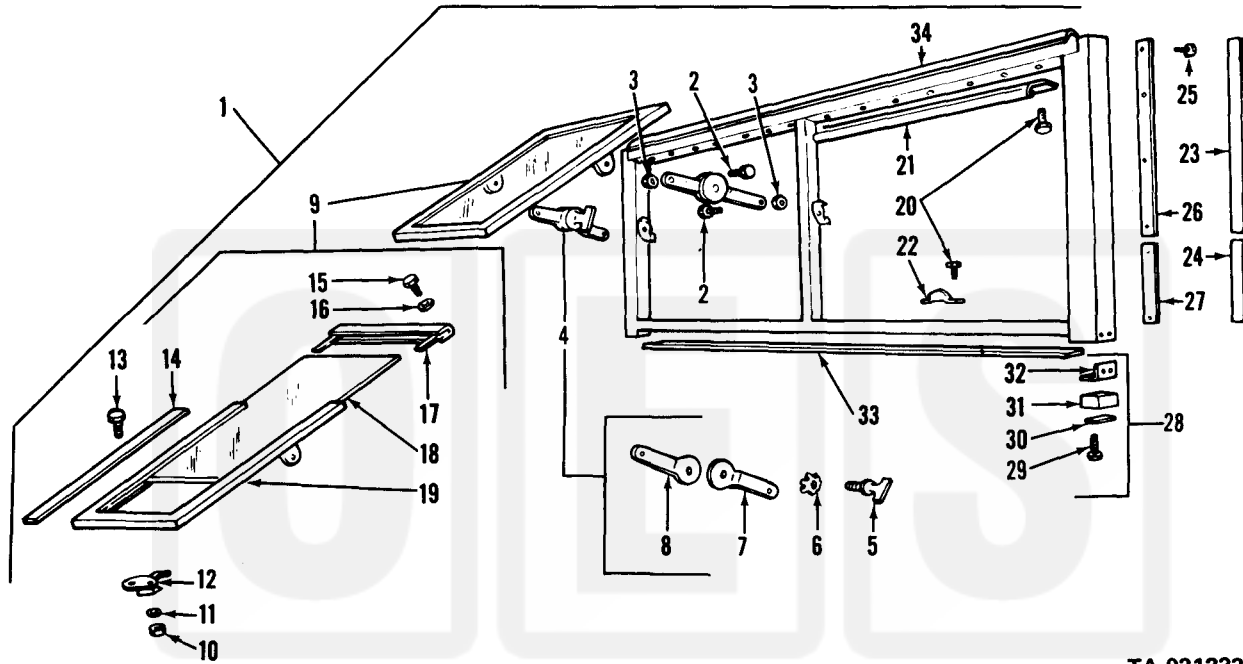

TA 031233

Figure 136. Windshield assembly.

Oshkosh
Equipment Sales

Current part is item (33) on diagram. Available at www.oshkoshequipment.com