

Current part is item (41) on diagram. Available at [www.oshkoshequipment.com](http://www.oshkoshequipment.com)

(1)	(2)	(3)	(4)	(5)	(6)	(7)	(8)
ILLUS.							QTY
(a)	(b)	SMR	NATIONAL	PART		DESCRIPTION	U/M
FIG.	ITEM	PAOZZ	STOCK	NUMBER	FSCM		INC
NO.	NO.		NUMBER			USABLE ON CODE	IN
							UNIT
						1801-BODY, CAB, HOOD, AND HULL ASSEMBLIES (CONT'D)	
134	30	PAOZZ		7529302	19207	LEAF	EA 1
134	31	PAOZZ	5315-00-059-0205	MS24665-490	96906	PIN, COTTER	EA 2
134	32	PAOZZ	2510-00-737-3288	7373288	19207	CHECK DOOR ASSEMBLY	EA 1
134	33	PAOZZ		8757842-1	19207	ROD	EA 1
134	34	PAOZZ	2510-00-057-1630	8757843	19207	PAD	EA 1
134	35	PAOZZ	9390-00-737-3291	7373291	19207	RUBBER, SPECIAL SHAPED SECTION: DOOR, SIDE 28-3/8 INCHES LONG	EA 1
134	36	PAOZZ	2510-00-737-3287	7373287	19207	WEATHERSTRIP: DOOR GLASS	EA 1
134	37	PAOZZ	3110-00-227-3250	MS57861-24	96906	SCREW, TAPPING, THREAD	EA 10
134	38	PAOZZ	5340-00-737-3283	7373283	19207	CLIP: WEATHERSEAL	EA 10
134	39	PAOZZ	9390-00-737-3292	7373292	19207	WEATHERSEAL: DOOR, BOTTOM 61-1/4 INCHES LONG	EA 2
134	40	PAOZZ	5330-00-737-2722	7372722	19207	WEATHERSTRIP: CAB TOP DOOR HEAD	EA 2
134	41	PAOZZ		7372721	19207	SEAL, RUBBER, SPECIAL: CAB TOP LOCK POST RIGHT (FABRICATED FROM 5330-00-737-2720)	EA 2
134	42	PAOZZ	5305-00-696-5285	187995	24617	SCREW	EA 1
134	43	PAOZZ	5340-00-737-3302	7373302	19207	STRIKE, CATCH, STRIKER, LOCK	EA 2
134	44	PAOZZ	5320-00-262-6492	MS16536-170	96906	RIVET, TUBULAR	EA 2
134	45	PAOZZ		164475	21450	SCREW	EA 2
134	46	PAOZZ	2540-00-737-3286	7373286	19207	CHANNEL, LIFT, VEHICLE WINDOW GLASS: CAB DOOR, REAR	EA 2
134	47	PAOZZ	2540-00-737-3298	7373298	19207	CHANNEL: GLASS RUN, FRONT	EA 2
134	48	PAOZZ	5305-00-879-7941	MS24617-31	96906	SCREW, MACHINE	EA 32
134	49	PAOZZ	2510-00-693-0589	7372716	19207	RETAINER, CAB TOP: LEFT DOOR HEADER WEATHERSTRIP	EA 2
134	50	PAOZZ	2510-00-693-0591	7372718	19207	RETAINER, CAB TOP: LEFT DOOR PILLAR POST WEATHERSTRIP	EA 1
134	50	PAOZZ	2510-00-693-0592	7372719	19207	RETAINER, CAP, TOP: DOOR PILLAR POST WEATHERSTRIP	EA 1



Current part is item (41) on diagram. Available at [www.oshkoshequipment.com](http://www.oshkoshequipment.com)

TM 9-2320-209-34P

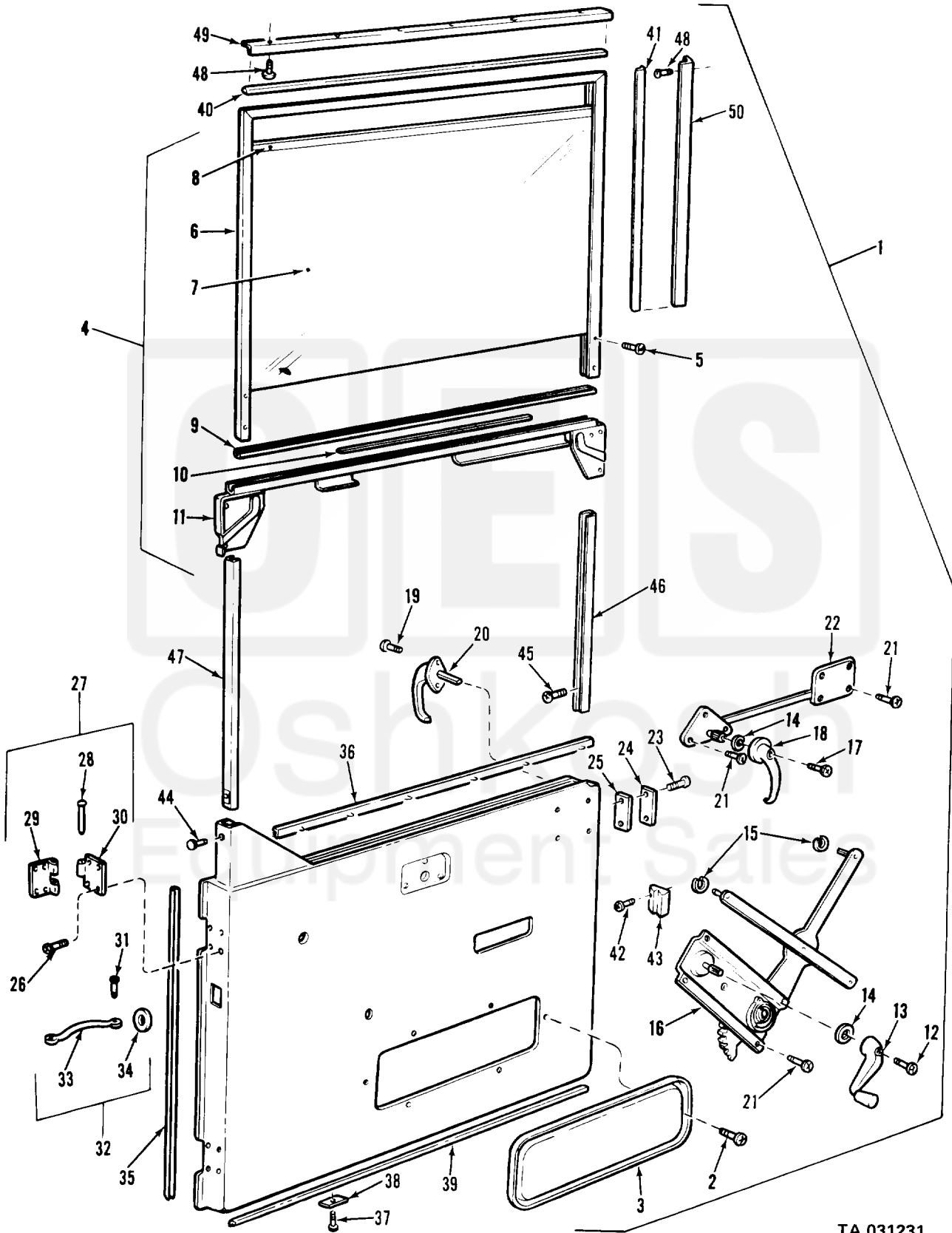

TA 031231

Figure 134. Cab door.