

Current part is item (16) on diagram. Available at www.oshkoshequipment.com
TM5-6115-585-24P
NAVFACP-8-623-24P
TO-35-3-455-4
SL-4-05684C/06585B

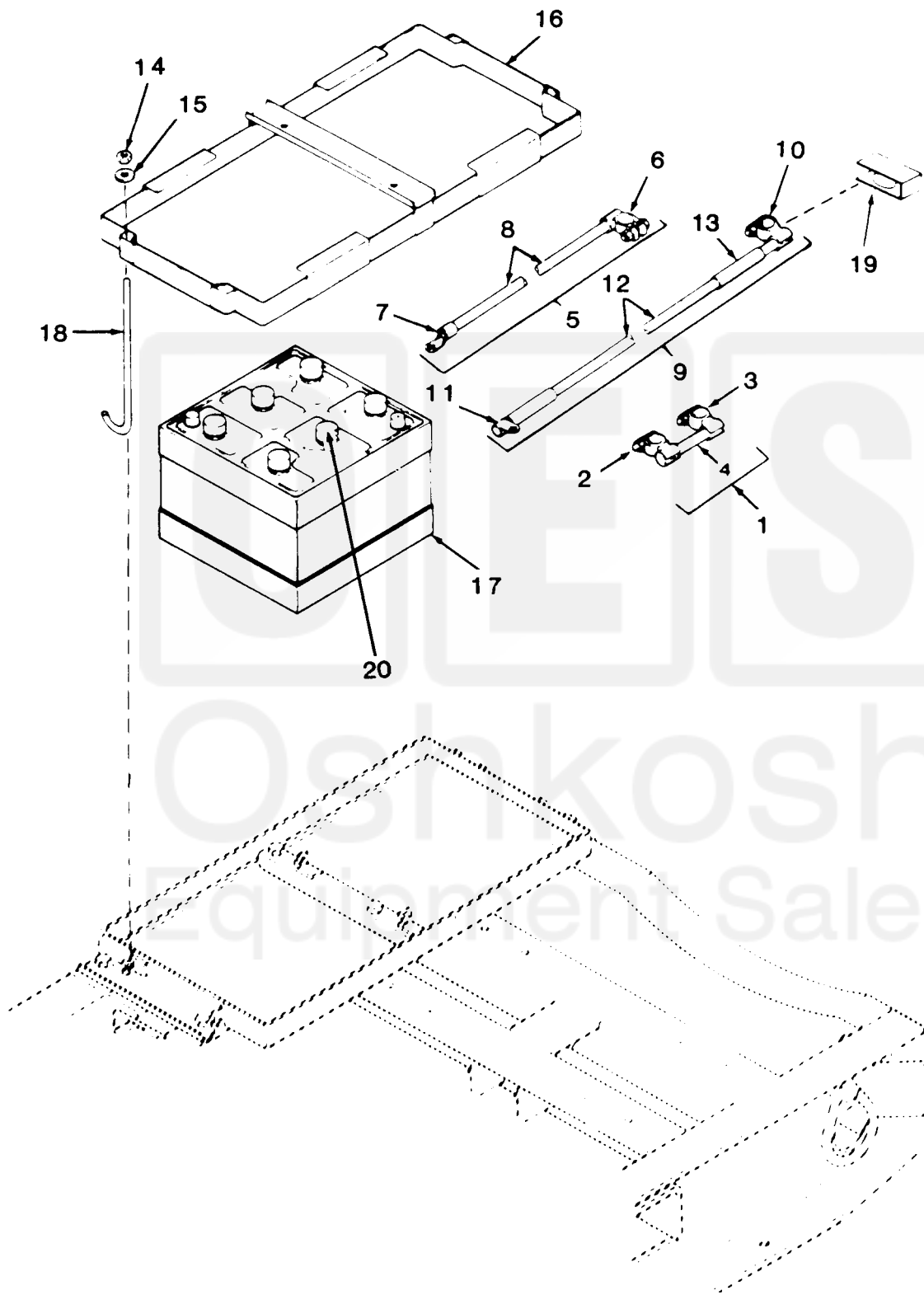

Figure 1. Battery assembly

8 Change 4

Current part is item (16) on diagram. Available at www.oshkoshequipment.com

TMS-6115-585-24E
 TMS-6115-585-24E
 TO35C2-3-455-4
 SL-4-05684C/06585B

(1) ILLUS- TRATION		(2) SMR CODE				(3) USMC		SECTION II REPAIR PARTS LIST (4)		(5) DESCRIPTION	(6)	(7)	(8)
A FIG NO.	B ITEM NO.	A ARMY	B AIR FORCE	C NAVY	D USMC	A SSI	B REPL FACTOR	NATIONAL STOCK NUMBER	REF NUMBER & MFR CODE	USABLE ON CODE	U/M	QTY INC IN UNIT	USMC QTY PER EQUIP
GROUP 01 BATTERY ASSEMBLY													
1	1	MOOOO	AOOZZ	XB	AFOZZ				LEAD, ELECTRICAL: STORAGE BATTERY JUMPER 72-5085 (30554)	EA		1	1
1	2	PAOZZ	PAOZZ	XB	PAFZZ	D	050	5940-00-606-4968	TERMINAL, LUG: POSITIVE 72-5099 (30554) 70063 (79550)	EA		1	2
1	3	PAOZZ	PAOZZ	XB	PAFZZ	D	050	5940-00-606-4969	TERMINAL, LUG: NEGATIVE 72-5098 (30554) 70078 (79550)	EA		1	2
1	4	PAOZZ	PAOZZ	XB	PAFZZ	D	050	6145-01-047-0530	CABLE, POWER 2 AWG SINGLE CONDUCTOR BLACK MIL-C-5756 (81349)	FT	V		
1	5	MOOOO	AOOZZ	XB	AFOZZ			5940-01-054-6954	LEAD, ELECTRICAL: STORAGE BATTERY - NEGATIVE 72-5082 (30554)	EA		1	1
1	6	PAOZZ	PAOZZ	XB	PAFZZ	D	050	5940-00-606-4969	TERMINAL, LUG: NEGATIVE 72-5098 (30554) 70076 (79550)	EA		1	2
1	7	PAOZZ	PAOZZ	XB	PAFZZ	D	050	5940-01-054-6954	TERMINAL, LUG: NO. 2 WIRE, 5/16 STUD 72-5319 (30554) 326896 (00779)	EA		1	1
1	8	PAOZZ	PAOZZ	XB	PAFZZ	D	050	6145-01-047-0530	CABLE, POWER 2 AWG SINGLE CONDUCTOR BLACK MIL-C-5756 (81349)	FT	V		
1	9	MOOOO	AOOZZ	XB	AFOZZ			6140-01-193-7683	LEAD, ELECTRICAL: STORAGE BATTERY - POSITIVE 72-5083 (30554)	EA		1	1
1	10	PAOZZ	PAOZZ	XB	PAFZZ	D	050	5940-00-606-4968	TERMINAL, LUG: POSITIVE 72-5099 (30554) 70083 (79550)	EA		1	1
1	11	PAOZZ	PAOZZ	XB	PAFZZ	D	050	5940-00-686-6880	TERMINAL, LUG: NO. 2 WIRE, 5/16 STUD MS25189-119 (96906)	EA		1	2
1	12	PAOZZ	PAOZZ	XB	PAFZZ	D	050	6145-01-047-0530	CABLE, POWER 2 AWG SINGLE CONDUCTOR, BLACK MIL-C-5756 (81349)	FT	V		
1	13	PAOZZ	PAOZZ	XB	PAFZZ	D	005	5970-00-914-3117	SLEEVEING, INSULATION M23053/5-109 (81349)	FT	V		
1	14	PAOZZ	PAOZZ	PAOZZ	PAOZZ	D	008	5310-00-767-0445	NUT, PLAIN, HEX: 5/16-18 MS51971-2 (96906)	EA		6	8
1	15	PAOZZ	PAOZZ	PAOZZ	PAOZZ	D	010	5310-00-802-4701	WASHER, FLAT: 3/8, SST MS15795-813 (96906)	EA EA		6 6	6 6
1	16	PBOZZ	XBOZZ	XB	XBOZZ			6140-01-049-1019	FRAME, BATTERY: TOP 72-5089 (30554) 416-0642 (44940)	EA		1	1
1	17	PAOZZ	PAOBZ	PAFZZ	PAOZZ		370	6140-00-057-2554	BATTERY, STORAGE: 12 VOLT, LEAD ACID MS35000-3 (96906)	EA		2	2
1	18	PAOZZ	PAOZZ	PAOZZ	PAOZZ	D	008	5306-01-049-9127	BOLT, HOOK 72-5094 (30554) 416-0513 (44940)	EA		6	6
1	19				PAOZZ	D	010	5940-00-738-6272	COVER, BATTERY TERMINAL 10942521 (19207)	EA		4	4
1	20	PAOZZ						6140-00-541-6716	CAP BATTERY MS75046-2 (96906)	EA		6	12

CHANGE 4 9

Oshkosh
Equipment Sales