

Current part is item (38) on diagram. Available at www.oshkoshequipment.com

(1) (a) FIG. NO.	(2) (b) ITEM NO.	(3) SMR CODE	(4) NATIONAL STOCK NUMBER	(5) (6) PART NUMBER	(5) (6) FSCM	(6) DESCRIPTION	(7) U/M	(8) INC IN UNIT
GROUP 12-BRAKES								
1201-HAND BRAKES								
111	1	PAOZZ	5306-00-752-1014	7521014	19207	BOLT,RIBBED NECK:PARKING BRAKE DRUM	EA	4
111	2	PAOZZ	2530-00-752-1490	7521490	19207	BRAKE DRUM: PARKING BRAKE	EA	1
111	8	XBOZZ		7529383	19207	SHIELD,GREASE: PARKING BRAKE DRUM	EA	1
111	9	PAOOO	2520-00-752-1276	7521276	19207	FLANGE,COMPANION W/DEFLECTOR ASSEMBLY: TRANSFER REAR SHAFT	EA	1
111	10	PAOZZ	2520-00-692-6080	7521242	19207	DEFLECTOR,DIRT AND LIQUID: COMPANION FLANGE	EA	1
111	11	PAOZZ	2520-00-134-5124	8757674	19207	FLANGE,COMPANION: BRAKE DRUM	EA	1
111	12	PAOZZ	5310-00-584-5272	MS35338-10	96906	WASHER,LOCK: PARKING BRAKE DRUM	EA	4
111	13	PAOZZ	5310-00-732-0560	MS51968-14	96906	NUT,PLAIN,HEXAGON: PARKING BRAKE DRUM	EA	4
111	14	PAOZZ	5315-00-013-7214	MS24665-359	96906	PIN,COTTER: BRAKE DRUM FLANGE	EA	1
111	15	PAOZZ	5310-00-752-1234	675762	58275	NUT,SLOTTED: BRAKE DRUM FLANGE	EA	1
111	16	PAOZZ	5310-00-752-1235	913701	58275	WASHER,FLAT:BRAKE DRUM FLANGE	EA	1
111	17	PAOZZ	5360-00-693-0615	7521284	19207	SPRING,HELICAL,EXTENSION:BRAKE SHOE ADJUSTING ANGLE RETURN	EA	1
111	18	PAOZZ	5310-00-880-7745	MS51968-11	96906	NUT,PLAIN,HEXAGON: BRAKE SHOE ADJUSTING SPRING SCREW	EA	1
111	20	PAOZZ	5305-00-709-8542	MS90727-91	96906	SCREW,CAP,HEXAGON HEAD: BRAKE SHOE ADJUSTING RETURN SPRING	EA	1
111	23	PAOFF	2530-00-693-0680	8380559	19207	BRAKESHOE ASSEMBLY:OUTER PARKING, W/LINING	EA	1
111	27	PAOZZ	4730-00-050-4208	MS15003-1	96906	FITTING,LUBRICATION: INNER AND OUTER BRAKESHOE	EA	2
111	28	PAOZZ	5310-00-333-7519	7064468	19207	WASHER,SLOTTED: BRAKESHOE PIN	EA	2
111	29	PAOFF	2530-00-693-0679	8380558	19207	BRAKESHOE ASSEMBLY: INNER PARKING, W/LINING	EA	1
111	33	PAOZZ	5315-00-316-0992	7064470	19207	PIN,SHOULDER,HEADED: BRAKESHOE	EA	1
111	34	PAOZZ	5360-00-342-7071	7373243	19207	SPRING,HELICAL,EXTENSION: LEVER RETURN	EA	1
111	35	PAOFF	3040-00-736-8683	7368683	19207	LEVER AND PIN ASSEMBLY: PARKING BRAKE ACTUATING	EA	1
111	38	PAOZZ	5365-00-664-2779	MS16633-1098	96906	RING,RETAINING: LEVER PIN	EA	2
111	39	PAOZZ	5340-00-321-6375	7064466	19207	SPRING:STABILIZER, BRAKESHOE	EA	1
111	40	PAOZZ	5310-00-297-3314	7064467	19207	WASHER,FLAT: BRAKE SPACER TIE RING	EA	4

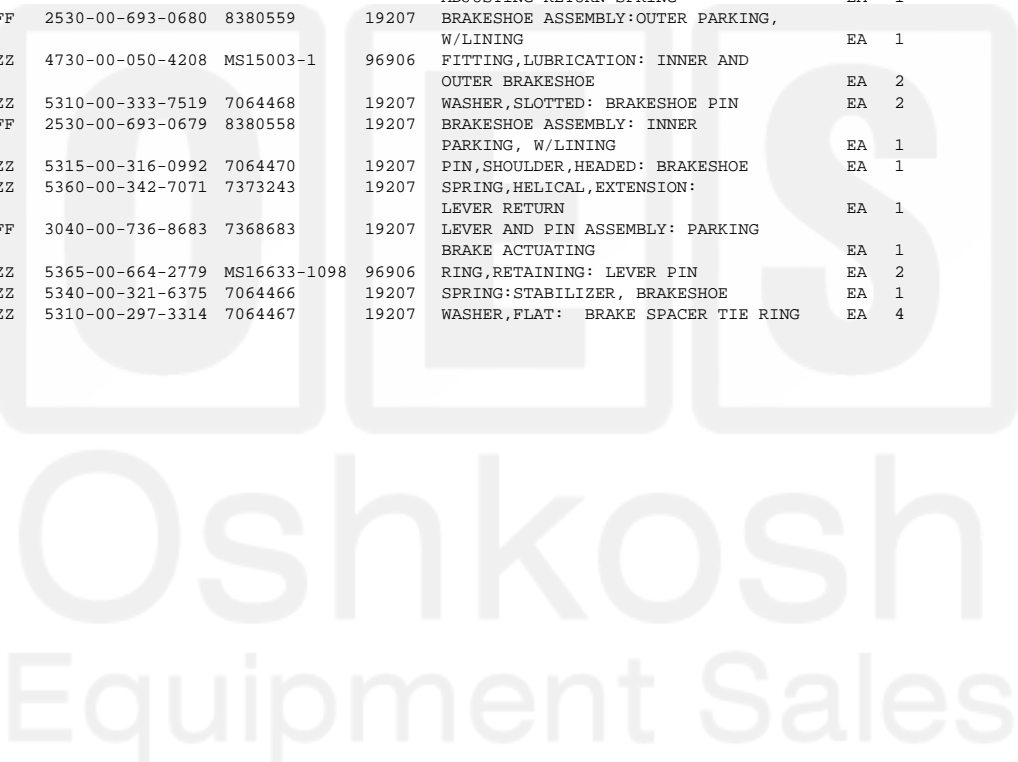

Current part is item (38) on diagram. Available at www.oshkoshequipment.com

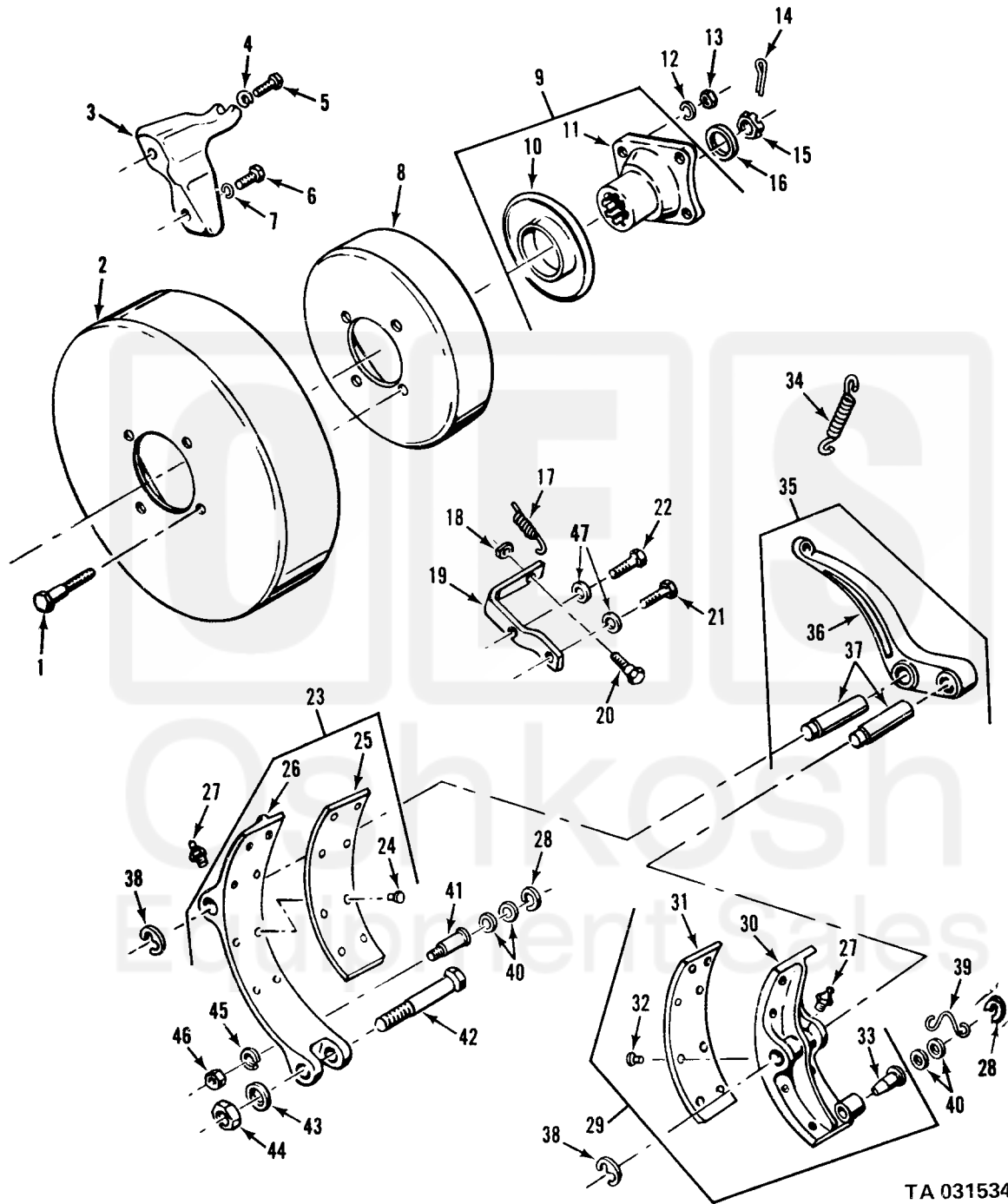

TA 031534

Figure 111. Parking brake drum and shoes.