

Section II.

TM 9-2320-272-34P-1

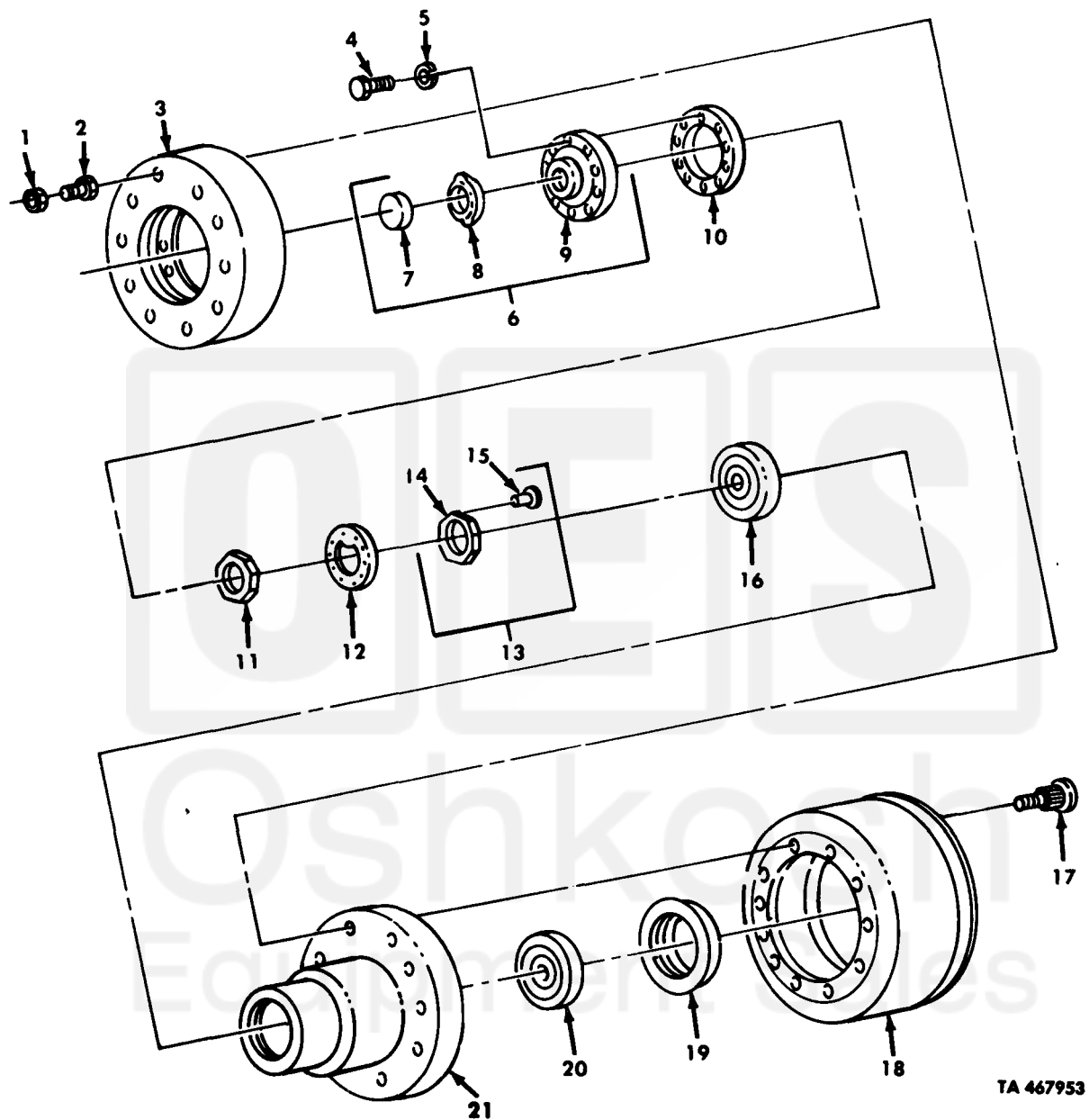

Figure 224. Front Wheel Hub and Drum Assembly.

Current part is item (17) on diagram. Available at [www.oshkoshequipment.com](http://www.oshkoshequipment.com)

ILLUS. (a) FIG. NO.	(b) ITEM NO.	SMR CODE	NATIONAL STOCK NUMBER	PART NUMBER	FSCM	DESCRIPTION  USABLE ON CODE	U/M	QTY INC IN UNIT
GROUP 1311 WHEEL ASSEMBLY FIG. 224 FRONT WHEEL HUB AND DRUM ASSEMBLY								
224	1	PAOZZ	5310-00-141-0447	10938443-1	19207	NUT, PLAIN, SINGLE WHEEL STUD LEFT UOC: DAA, DAB, DAC, DAD, DAE, DAF, DAG, DAH, DAJ, DAK, DAL, DAQ, DAR, DAW, DAX, V06, V07, V12, V13, V14, V15, V16, V17, V18, V19, V20, V21, V22, V24, V25	EA	10
224	1	PAOZZ	5310-00-480-7606	10938443-2	19207	NUT, PLAIN, SINGLE WHEEL STUD RIGHT UOC: DAA, DAB, DAC, DAD, DAE, DAF, DAG, DAH, DAJ, DAK, DAL, DAQ, DAR, DAW, DAX, V06, V07, V12, V13, V14, V15, V16, V17, V18, V19, V20, V21, V22, V24, V25	EA	10
224	1	PAOZZ	5310-00-176-6525	10938444-1	19207	NUT, PLAIN, SINGLE WHEEL STUD, LEFT UOC: DAV, V39	EA	10
224	1	PAOZZ	5310-00-176-6521	10938444-2	19207	NUT, PLAIN, SINGLE WHEEL STUD, RIGHT UOC: DAV, V39	EA	10
224	2	PAOZZ	2530-00-359-1162	MS53068-2	96906	NUT, CAP, DUAL WHEEL RIGHT UOC: DAV, V39	EA	10
224	2	PAOZZ	2530-00-693-1029	MS53068-1	96906	NUT, CAP, DUAL WHEEL LEFT UOC: DAV, V39	EA	10
224	3	PAOZZ	2530-00-741-1105	3280-B-1978	78500	ADAPTER, BRAKE DRUM UOC: DAV, V39	EA	2
224	4	PAOZZ	5306-00-182-9267	10896726	19207	BOLT, MACHINE	EA	20
224	5	PAOZZ	5310-00-584-5272	MS35338-48	96906	WASHER, LOCK	EA	20
224	6	PAOOO	2520-00-734-6991	7346991	19207	FLANGE, COMPANION	EA	2
224	7	PAOZZ	5340-00-734-6992	7346992	19207	PLUG, EXPANSION	EA	1
224	8	PAOZZ	5330-00-291-3273	MS29513-229	96906	PACKING, PREFORMED	EA	1
224	9	XAOZZ		8758278	19207	FLANGE ASSEMBLY	EA	1
224	10	PAOZZ	5330-00-734-6993	7979275	19207	GASKET	EA	2
224	11	PAOZZ	5310-00-353-2427	7979263	19207	NUT, PLAIN	EA	2
224	12	PAOZZ	5310-00-700-7089	5139123	19207	WASHER, KEY	EA	2
224	13	PAOZZ	5310-00-374-0836	7979308	19207	NUT, PLAIN	EA	2
224	14	XAOZZ		7979309	19207	NUT, OUTER WHEEL BEARING	EA	1
224	15	XAOZZ		7979310	19207	PIN, ADJUSTMENT	EA	1
224	16	PAOZZ	3110-00-100-4223	MS19081-181	96906	BEARING, ROLLER OUTER	EA	2
224	17	PAOZZ	5307-01-142-4783	20X-1529	78500	STUD LEFT FRONT WHEEL UOC: DAV, V39	EA	10
224	17	PAOZZ	5307-01-142-4784	20X-1528	78500	STUD RIGHT FRONT WHEEL UOC: DAV, V39	EA	10
224	17	PAOZZ	5307-01-132-8273	20X-1337X	78500	STUD, LEFT FRONT WHEEL UOC: DAA, DAB, DAC, DAD, DAE, DAF, DAG, DAH, DAJ, DAK, DAL, DAQ, DAR, DAW, DAX, V06, V17, V12, V13, V14, V15, V16, V17, V18, V19, V20, V21, V22, V24, V25	EA	10
224	17	PAOZZ	5307-01-132-8274	20X-1336	78500	STUD, RIGHT FRONT WHEEL UOC: DAA, DAB, DAC, DAD, DAE, DAF, DAG, DAH, DAJ, DAK, DAL, DAQ, DAR, DAW, DAX, V06, V07, V12, V13, V14, V15, V16, V17, V18, V19, V20, V21, V22, V24, V25	EA	10
224	18	PAOFF	2530-01-134-6570	3219-C-4345	78500	DRUM, BRAKE FRONT	EA	2
224	19	PAOZZ	5330-00-740-9550	7979349	19207	SEAL, PLAIN ENCASED	EA	2
224	20	PAOZZ	3110-00-100-4220	MS19081-137	96906	BEARING, ROLLER	EA	2
224	21	PAOZZ	3040-01-139-1611	A333-T-2334	78500	HUB, FRONT WHEEL	EA	2
END OF FIGURE								

Current part is item (17) on diagram. Available at [www.oshkoshequipment.com](http://www.oshkoshequipment.com)