

(1) SMR Code	(2) Federal Stock Number	(3) Description	(4) Unit of Meas.	(5) Qty In Unit	(6) 15-day Maintenance allow	(7) Organizational Illustration	(a) Figure No.	(b) Item No.
Reference number & mfg. code			Usable on code		(a) (b) (c) (d)	(a) (b)	(a) (b)	
					1-5 6-20 21-50 51-100	No.	No.	
		1201-HANDBRAKES-CONTINUED						
PAOZZ	2530-312-1583	DEFLECTOR,DIRT AND OIL: COMPANION FLANGE 7409371(19207)	A	EA	1 * * * *	104	6	
PAOZZ	2520-734-6802	FLANGE ASSEMBLY,COMPANION: 7346802 (19207)	A	EA	1 * * * *	104	7	
PAOZZ		WASHER,FLAT: COMPANION FLANGE 7375259(19207)	A	EA	1 * * * *	104	8	
PAOZZ	5310-492-9631	NUT,SLOTTED,HEXAGON: COMPANION FLANGE A143813(76040)	A	EA	1 * * * *	104	9	
PAOZZ	5315-059-0184	PIN,COTTER: SLOTTED NUT MS24665-361(96906)	A	EA	1 * * * *	104	10	
PAOZZ	5310-732-0559	NUT,PLAIN,HEXAGON: DRUM TO FLANGE MS51968-8(96906)	A	EA	8 * * * *	104	11	
PAOFF	2530-693-0679	BRAKE SHOE,INTERNAL: 8380558(19207)	A	EA	1 * * * *	104	12	
PAOZZ	5310-297-3314	WASHER,FLAT: BRAKE SHOE 7064467(19207)	A	EA	4 * * * *	104	13	
PAOZZ	5310-637-9541	WASHER,LOCK: 3/8 NOM SIZE,BRAKE SHOE MS35338-46(96906)	A	EA	3 * * * *	104	14	
PAOZZ	5315-316-0992	PIN,SHOULDER,HEADLESS: BRAKE SHOE 7064470(19207)	A	EA	1 * * * *	104	15	
PAOZZ	5365-752-1285	RING,RETAINING: SHOE LEVER PIN(2), SHOE ANCHOR BOLT(1) 7521285(19207)		EA	3 * * * *	104	16	
PAOZZ	2530-736-8683	LEVER ASSEMBLY, SHOE: 7368683(19207)	A	EA	1 * * * *	104	17	
PAOZZ	5315-312-0831	PIN,GROOVED,HEADLESS: SHOE LEVER 7521448(19207)		EA	2 * * * *	104	18	
XAOZZ		LEVER,SHOE: 8757709(19207)			1	104	19	
PAOZZ	5315-018-7988	PIN,COTTER: EXTENSION SPRING MS24665-493(96906)		EA	1 * * * *	104	20	
PAOZZ	5360-740-9447	SPRING,HELICAL,EXTENSION: BRAKE LEVER 7409447(19207)	A	EA	1 * * * *	104	21	
PAOZZ	5306-740-9370	BOLT,MACHINE: BRAKE SHOE 7409370(19207)	A	EA	1 * * * *	104	22	
PAOZZ	5310-333-7519	PIN,SHOULDER,HEADLESS: BRAKE SHOE 7064468(19207)	A	EA	1 * * * *	104	23	
PAOZZ	2530-321-6375	SPRING,BRAKE SHOE: 7064466(19207)	A	EA	1 * * * *	104	24	
PAOFF	2530-693-0680	BRAKE SHOE WITH LINING: OUTER 8380559(19207)	A	EA	1 * * * *	104	25	

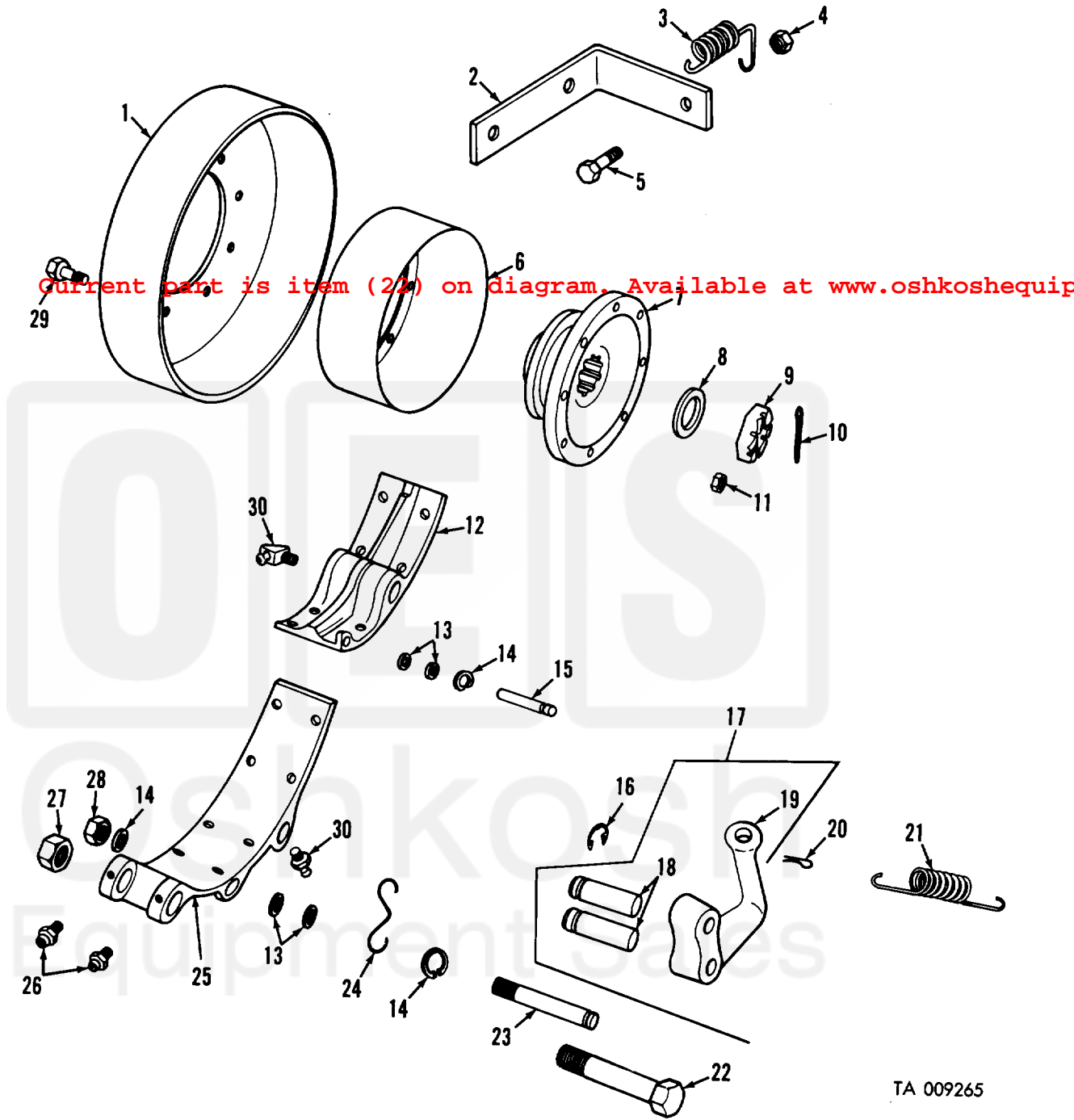

Figure 104. Parking brake drum and shoe.

TA 009265

Current part is item (22) on diagram. Available at www.oshkoshequip.com